

GROUP 45 PROPELLER SHAFTS

Description

The vehicle is provided with two propeller shafts which are placed between the auxiliary gearbox and the differential carrier, see Figs. 45-1 and 45-2. Both propeller shafts are provided with slip joints in order to take up the changes that arise between the

gearbox and differential carrier. To ensure complete lubrication of the spiders in the universal joints and the slip joints, the shafts are provided with lubricating nipples and in order to protect the slip joint, it is protected with a rubber bellows cover.

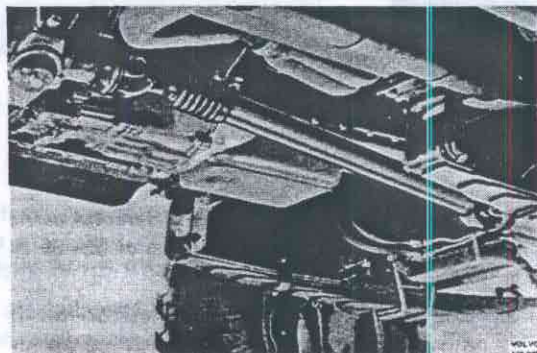

Fig. 45-1. Front propeller shaft

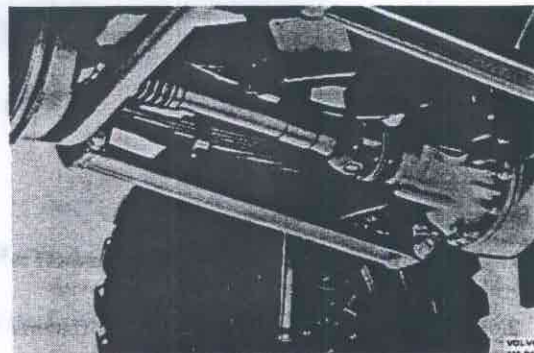

Fig. 45-2. Rear propeller shaft

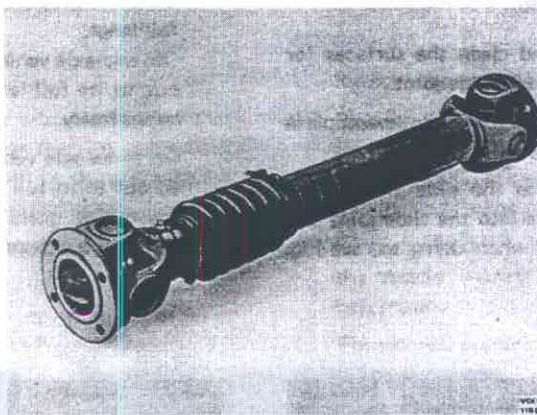

Fig. 45-3. Propeller shaft

Service procedures

Replacing a propeller shaft

When replacing a propeller shaft, any lock washers should be replaced and the slip joint rubber bellows cover checked for damage. When fitting the flanges, always make sure that the contact surfaces are clean and free from dirt. The bolts should always be tightened to a torque of 55–65 Nm (5.5–6.5 kpm =

40–47 lbftf) and the spiders as well as the slide joint should be lubricated. The spider should be greased so much that grease squeezes out at all four needle bearings. Grease the slide joint until squeezes out at the overflow valve (in the centre of the fork or when the slide joint shows a tendency to extend itself).

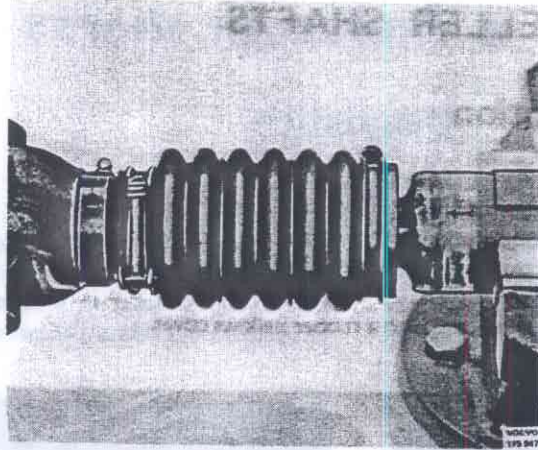

Fig. 45-4. Removing the axel

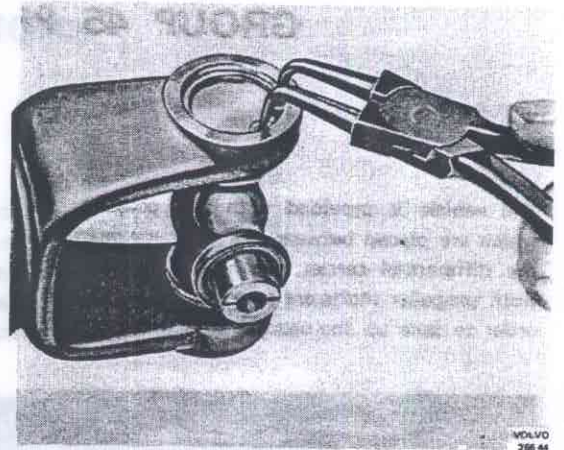

Fig. 45-6. Removing the circlip

Replacing the rubber bellows

1. Jack up the vehicle so that the wheels are off the ground.
2. Remove the propeller shaft from the differential carrier flange.
3. Remove the hose clamps on the rubber bellows. Pull out the propeller shaft tube from the slide joint.
4. Remove the bellows and clean the surfaces for the bellows on the tube and slide joint.
5. Fit the hose clamps on the new bellows and place the bellows on the propeller shaft tube.
6. Check to make sure that the slide joint is free from dirt. Push the tube into the slide joint and note the line-up marks when doing so, see Fig. 45-4.

7. Fit the propeller shaft to the differential carrier. Tighten up the bolts to a torque of 55–65 Nm (5.5–6.5 kpm = 40–47 lbftf).
8. Place the rubber bellows in position on the propeller shaft tube. Fit and tighten up the hose clamp.
9. Before tightening up the other end of the bellows, the propeller shaft must be pulled out to its full length.
On two-axle vehicles, the propeller shaft is pulled out to its full length when the wheel carrier gear hangs freely.
On three-axle vehicles, the propeller shaft is pulled out to its full length to the bogie when one of the carrier gears hangs freely and the other is raised to a maximum.

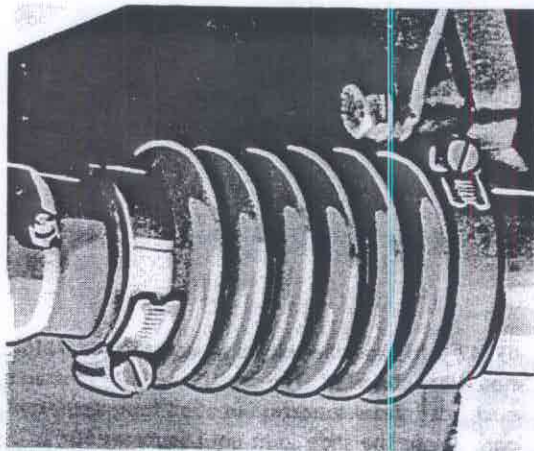

Fig. 45-5. Adjusting the clamp

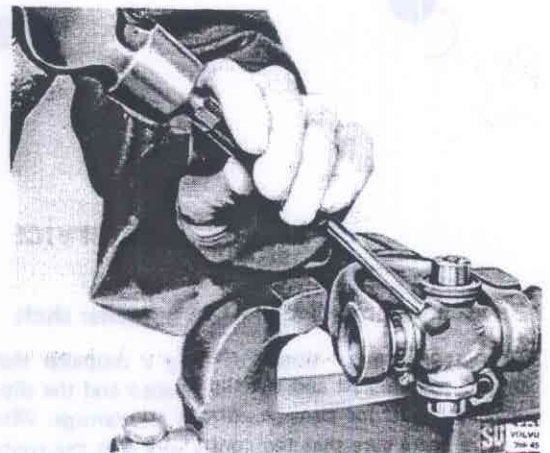

Fig. 45-7. Driving out the bearing

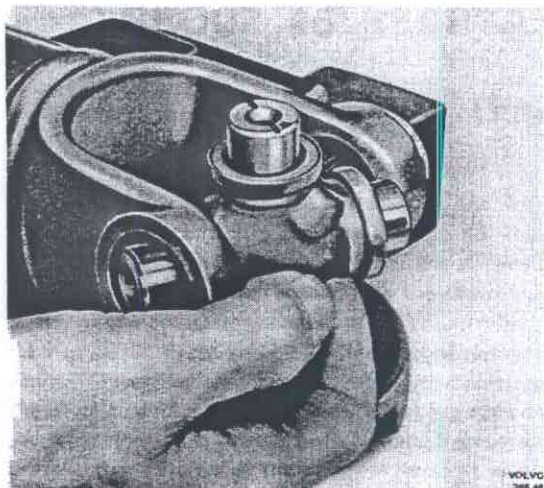

Fig. 45-8. Removing the spider

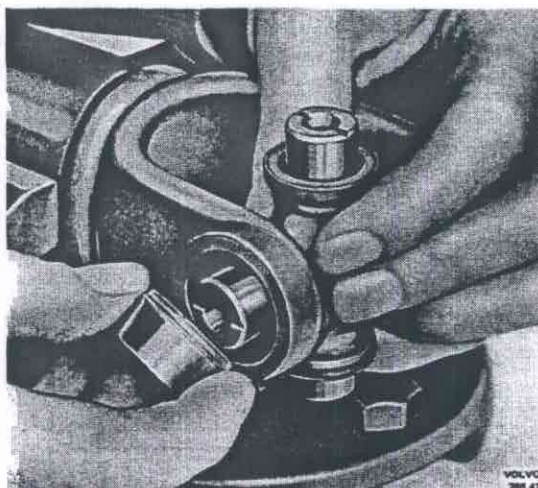

Fig. 45-9. Fitting the bearing

10. Lower the vehicle.
11. Lubricate the slide joint. This must be done when the vehicle is lowered otherwise too much grease can be added.

Replacing universal joint

Disassembling

1. Secure the propeller shaft tube in a vice so that the universal joint is as near the vice as possible. Note that the tube must not be damaged since if it is deformed it can cause imbalance.
2. Remove the circlips securing the needle bearings, see Fig. 45-6.
3. With the help of a drift drive the spider as far as possible in one direction, see Fig. 45-7.
4. Then drive the spider in the opposite direction as far as possible.

5. Drive out one of the needle bearings with a narrow drift. Remove the spider, see Fig. 45-8. Drive out the other needle bearing.
6. Fit the flange in a vice and remove the spider from the flange in the same way as from the tube.

Assembling

1. Remove the needle bearings from the spider.
2. Place the spider in the flange, see Fig. 45-9, and fit the needle bearing. Make sure that the rollers in the bearing are located correctly. Press in the bearing and fit the circlip.
3. Push the spider in the one direction so far that the needle bearing can be fitted. Press in the bearing and fit the circlip.
4. Fix securely the spider in the propeller shaft tube in the same way.
5. Lubricate the spider.

GROUP 46 REAR AXLE AND FRONT AXLE

Description

DIFFERENTIAL CARRIERS

The differential carriers, see Figs. 46-1 and 46-2 as well as Illustrations 46-A and -B, are of the so-called "spiral-bevel" type which means that the centreline of the pinion coincides with that of the crown wheel, see Fig. 46-3. Front and rear differential carriers are similar. Since they are turned in their own direction, the drive side of the crown wheel is not regarded as the same side as the gears in both carriers. In order to prevent the differential pinion from rotating when driving on a slippery surface, the differentials are provided with a lock, see Figs. 46-4 and 46-5. The lock is operated from a control panel, see Fig. 46-6. The control cylinder on the rear axle casing or front axle casing is actuated by vacuum. In order to indicate when the control cylinder is under vacuum, indicators are placed on the line to the front and rear axle casings respectively (Fig. 46-7). They switch on the differential lock lights on the instrument panel.

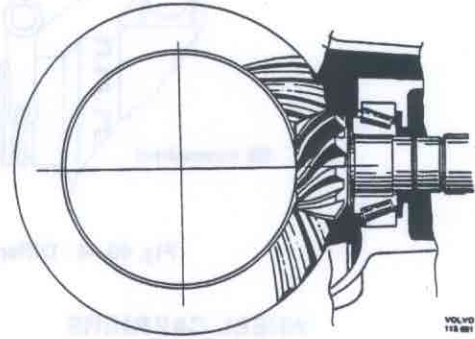

Fig. 46-3. Spiral bevel

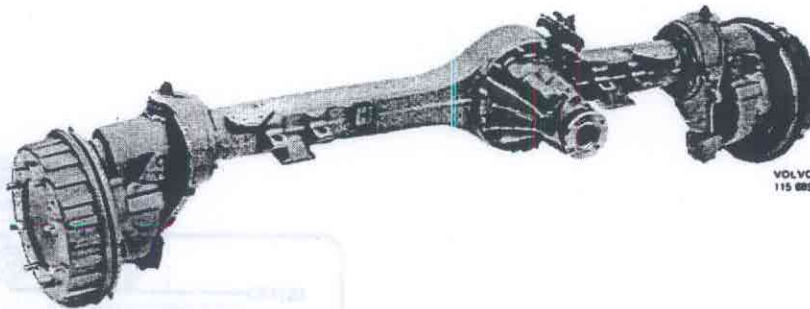

Fig. 46-1. Front axle

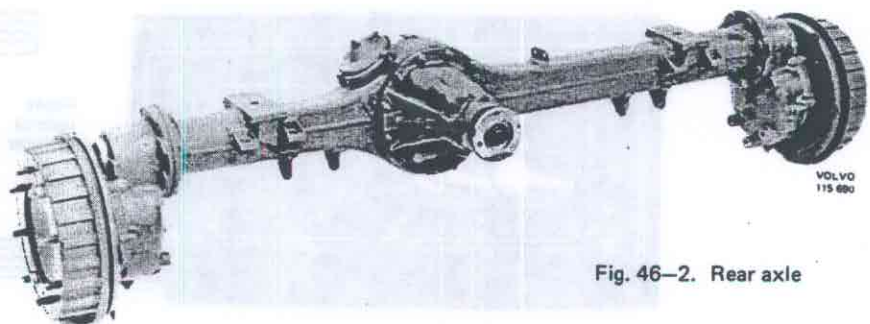

Fig. 46-2. Rear axle

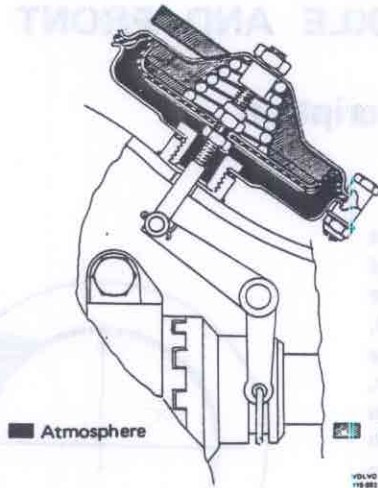

Fig. 46-4. Differential lock

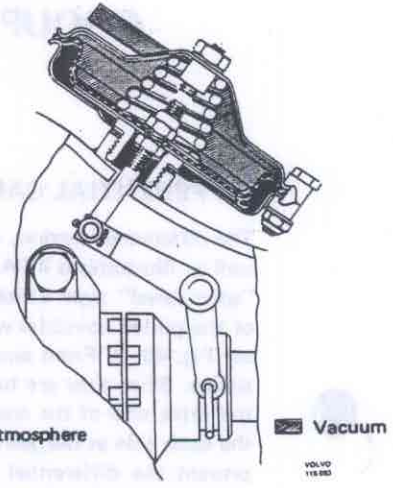

Fig. 46-5. Differential lock

WHEEL CARRIERS

In order that the vehicle should have a high ground clearance without the necessity of having excessively large wheels, the front and rear axles have been provided with wheel carriers, see Figs. 46-8 and 46-9. The wheel carriers consist of a large and a small gear, see the Illustration 46-C, E and F. the gears have straight teeth. The small gear is journaled in the wheel carrier housing in a ball bearing and a needle bearing. The large gear is fixed to the wheel hub

shaft, which is journaled in a housing bolted to the wheel carrier housing. The housing is partly filled with oil for lubricating the wheel carriers.

To prevent oil from the wheel carrier running over into the differential carrier casing, a seal is fixed on the rear wheel carrier housing. This seal consists of a sealing ring with wear ring, Illustration 46-D, and an X-ring which sits on the drive shaft. The seal for the front wheel carrier consists of rubber bellows, see Illustration 46-C.

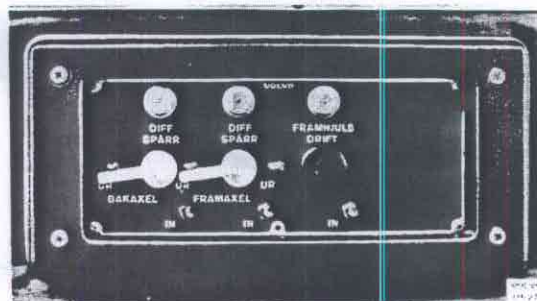

Fig. 46-6. Operating controls

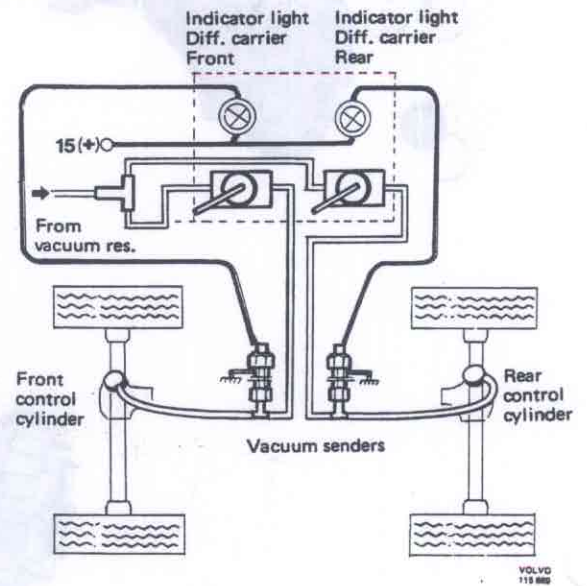

Fig. 46-7. Diff. carrier senders and indic. lights

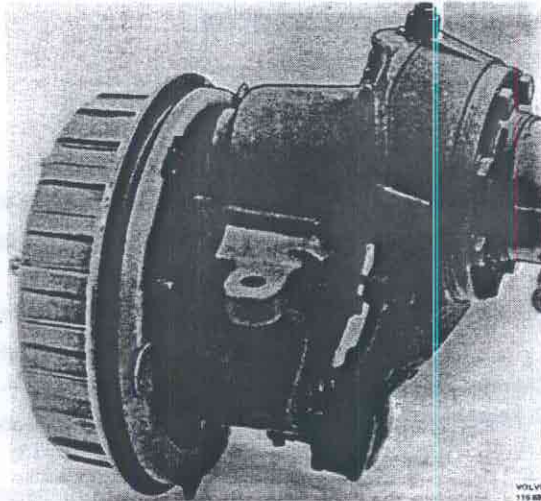

Fig. 46-8. Front wheel carrier

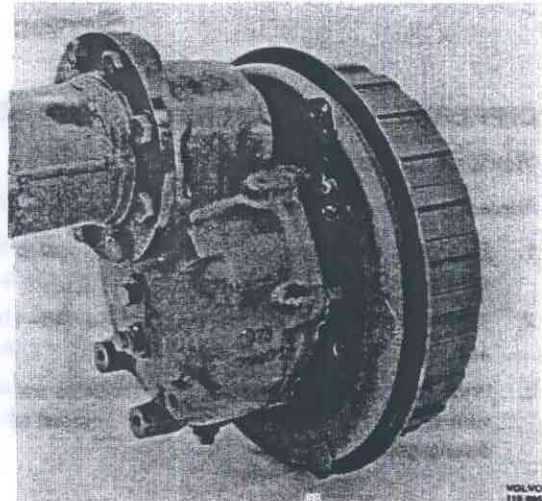

Fig. 46-9. Rear wheel carrier

Power take-off for tandem drive

On 3-axle vehicles with tandem drive, the leading differential carrier, Fig. 46-10, is fitted with a power take-off for driving the trailing differential carrier. A propeller shaft is fitted between the power take-off and the trailing differential carrier. The power take-off is fixed to the differential carrier housing. It differs, therefore, from the vehicle's two other differential carriers by the fact that it has a cover in the housing and a gear wheel which sits on the pinion.

The construction of the power take-off can be seen from Fig. 46-11 and Illustrations 46-G and H. It consists of two parts, a housing in which two gears are journaled and a housing in which the output shaft is journaled. One of the gears, called the intermediate gear, cannot be displaced on its shaft but is in constant mesh with the gear on the pinion and the gear on the power take-off. The power take-off output shaft will, therefore, always rotate at the same speed as the speed of the pinion.

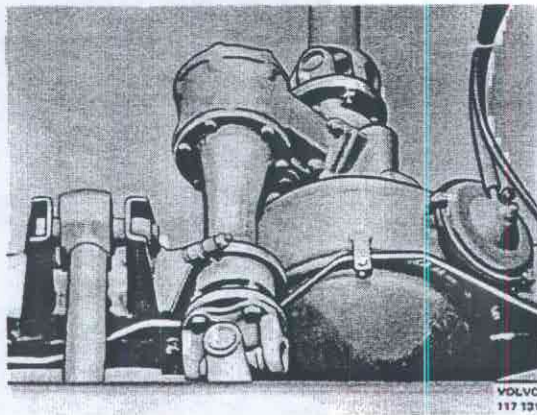

Fig. 46-10. Power take-off on the differential carrier

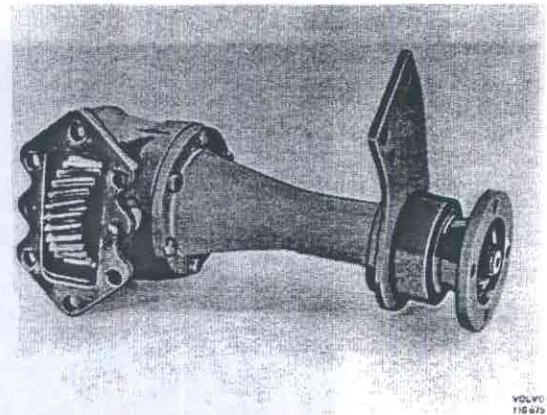

Fig. 46-11. Power take-off

Service procedures

DIFFERENTIAL CARRIERS

Work on carriers in vehicle

Replacing O-rings on differential lock control handle

1. Place a suitable tool under the handle, and pull the handle out of the housing.
2. Replace the O-ring on the handle, Fig. 46-12, and coat it with a little grease.
3. Press the handle into the housing. Check to make sure that the differential lock can be engaged and disengaged.

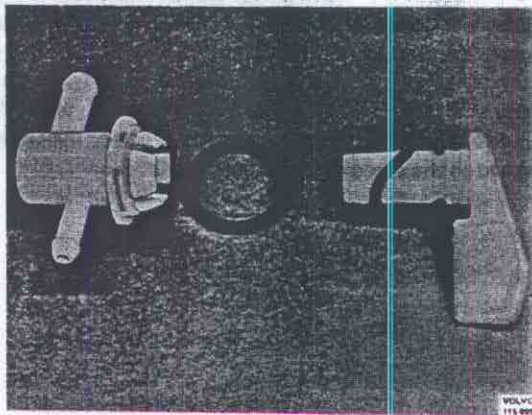

Fig. 46-12. Differential lock control

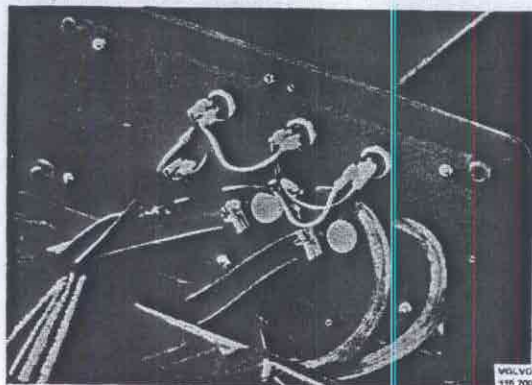

Fig. 46-13. Differential lock controls

Replacing differential carrier control

1. Place a suitable tool under the knob and pull the knob out of the housing.
2. Remove the four screws securing the plate.
3. Remove the lock ring which holds the control housing to the controls panel.
Screw loose the panel. Disconnect the hoses from the housing, see Fig. 46-13.
4. Remove the knob from the new control.
5. Place a new O-ring on the housing and fit the housing on the panel. Fit the lock ring.
6. Connect up the hoses. Fit the panel. Screw tight the plate.
7. Press the knob into the housing. Check the function of the differential carriers.

Replacing the flange seal

1. Remove the bolts holding the propeller shaft and remove the shaft.
2. Fix counterhold 2837 on the flange, Fig. 46-14. Unscrew the nut.
3. Fit puller 2261, Fig. 46-15, and pull off the flange.
4. Pull out the seal with 4030, Fig. 46-16.

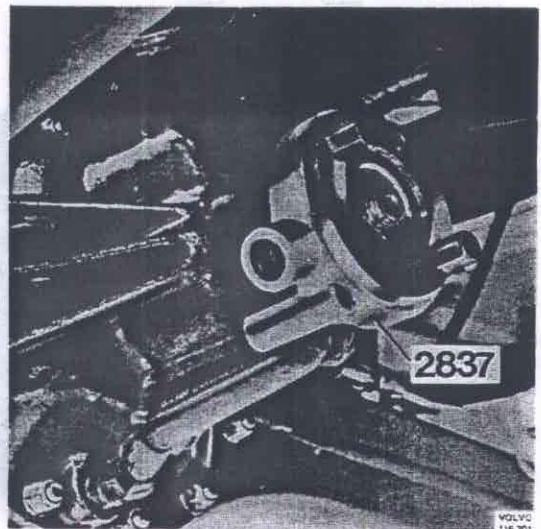

Fig. 46-14. Fitting a counterhold

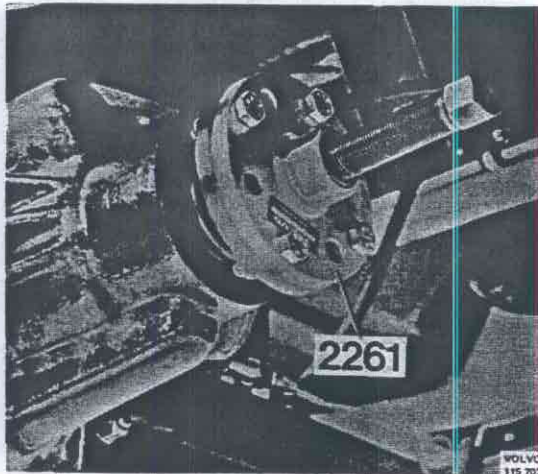

Fig. 46-15. Removing the flange

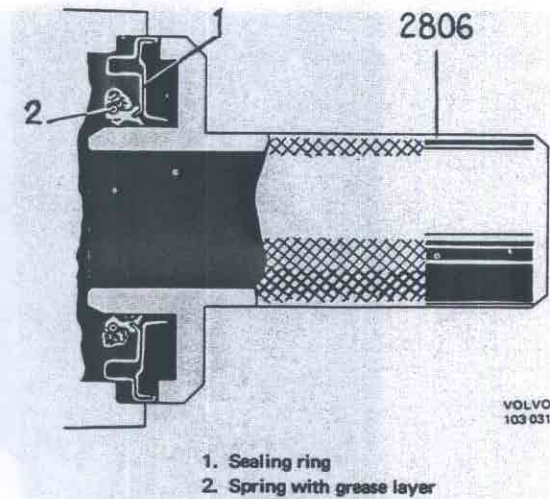

Fig. 46-17. Installing the sealing ring

5. Grease the contact surface of the new seal which faces the flange and on the reverse side of the sealing lip, Fig. 46-17.
6. Drive the seal into the housing with 2806.
7. Pull on the flange with 1845, Fig. 46-18. Remove the tool and fit 2837. Fit the nut and tighten it to a torque of 280–300 Nm (28–30 kpm = 202–217 lbftf).
8. Fit and tighten up the propeller shaft. Tighten the bolts to a torque of 55–65 Nm (5.5–6.5 kpm = 40–47 lbftf).

Replacing the control cylinder diaphragm

1. Remove the bolts, Fig. 46-19, holding the cylinder cover. Remove the cover.
2. Remove the spring. Remove the nut on the pull rod. Hold securely the thrust washer and diaphragm.

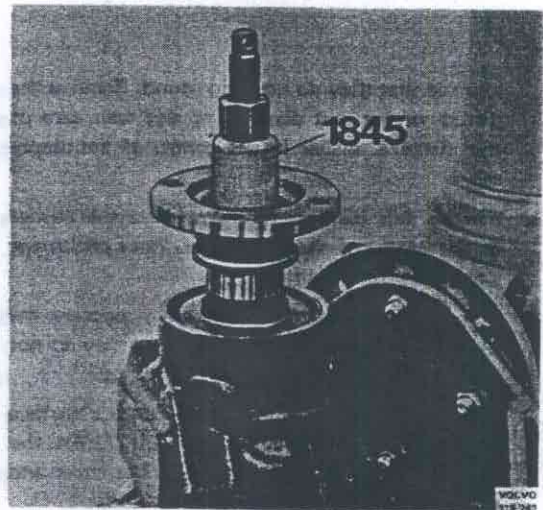

Fig. 46-18. Pressing on the flange

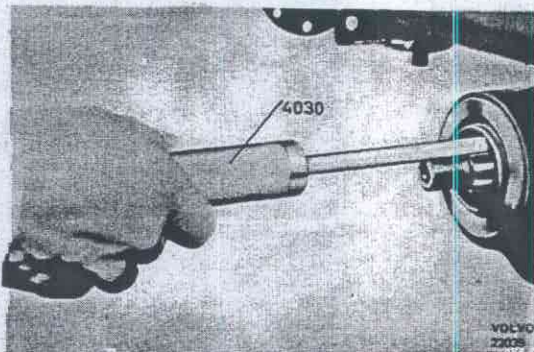

Fig. 46-16. Removing the seal

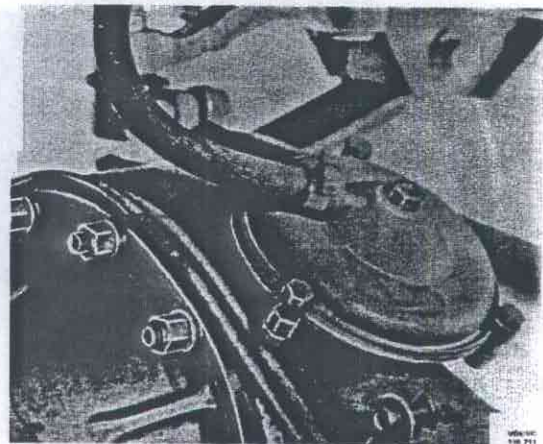

Fig. 46-19. Control cylinder